

FSB push/pull pad handles

S-Flat series



Finest Bauhaus tradition:
S-Flat push/pull pad handle series



We have created a new design line with our S-Flat push/pull pad handle series that heralds quite a departure from the door pulls generally encountered hitherto. Our in-house designer Hartmut Weise has, in the finest Bauhaus tradition, opted for a geometrical approach in his concept that sees every straight-cornered handle matched by a rounded variant. S-Flat handles incorporate stainless steel plates 5 mm thick that are cut to size by laser to form ten different push/pull pad handle designs. Their planar, rigorously pared-down styling gives them the appearance of graphic elements and, as such, they open up radically new design options when fitted to either glazed or flush doors.

Common to all models is a gripping face angled 15° away from the door and hence invitingly towards the user. The hardware's enticing impact on the eye is reinforced by what the hand then experiences: the reverse of each S-Flat handle is softly padded with haptic, ergonomically curved elements in Technogel®.

S-Flat handles come in a variety of dimensions as well as in either open or closed forms.

S-Flat push/pull pad handle series

straight-cornered

Details of fastening are to be found in the latest FSB Manual.

61 6187 | 61 6188 ■

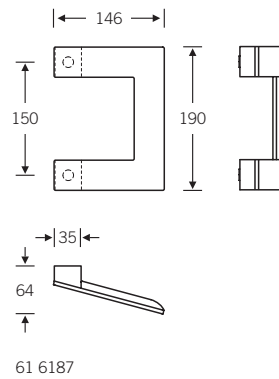

straight-cornered, open
Brackets silver-grey powder-coated

M8 fastenings

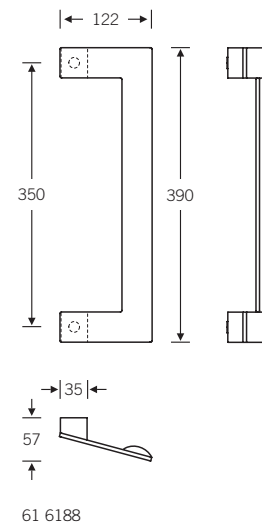

61 6189 | 61 6190 ■

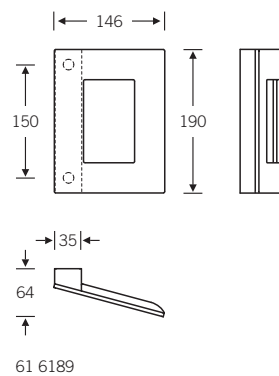

straight-cornered, closed
Brackets silver-grey powder-coated

M8 fastenings

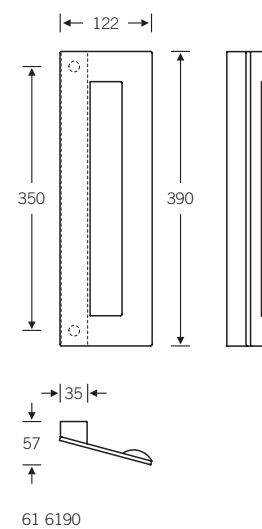

fsb.de/616187
fsb.de/616188
fsb.de/616189
fsb.de/616190

Design: Hartmut Weise

Fastenings (not supplied):

- back-to-back fixing
 - for flush doors: 05 0587 030..
 - for glazed doors: 05 0587 01008
- face fixing with threaded insert
 - for flush doors: 05 0587 00335

S-Flat push/pull pad handle series

round

Details of fastening are to be found in the latest FSB Manual.

61 6192 | 61 6193 ■

round, open
Brackets silver-grey powder-coated

M8 fastenings

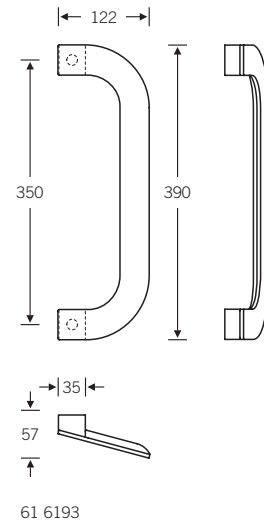
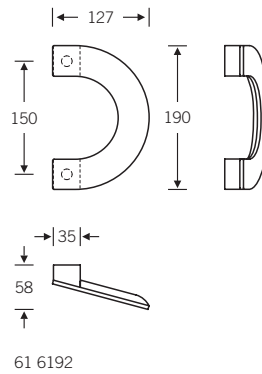

61 6195 ■

round, closed
Brackets silver-grey powder-coated

M8 fastenings

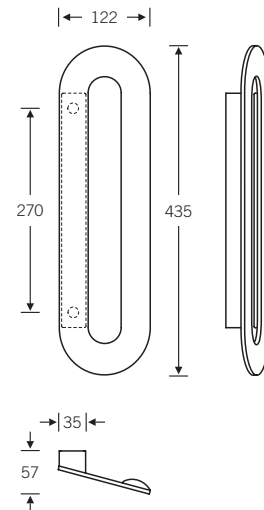

fsb.de/616192
fsb.de/616193
fsb.de/616195

Design: Hartmut Weise

Fastenings (not supplied):

- back-to-back fixing
 - for flush doors: 05 0587 030..
 - for glazed doors: 05 0587 01008
- face fixing with threaded insert
 - for flush doors: 05 0587 00335

S-Flat push/pull pad handle series

square + circle

Details of fastening are to be found in the latest FSB Manual.

61 6186 | 61 6191 ■

square, planar
Brackets silver-grey powder-coated

M8 fastenings

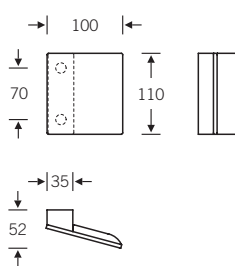

61 6186

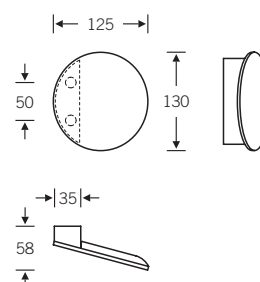

61 6191

61 6194 ■

circle, closed
Brackets silver-grey powder-coated

M8 fastenings

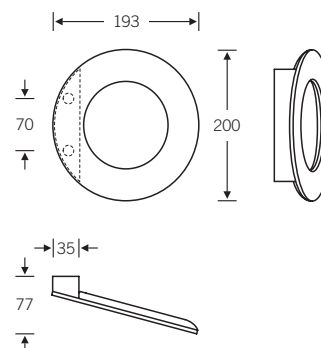

fsb.de/616186
fsb.de/616191
fsb.de/616194

Design: Hartmut Weise

Fastenings (not supplied):

- back-to-back fixing
 - for flush doors: 05 0587 030..
 - for glazed doors: 05 0587 01008
- face fixing with threaded insert
 - for flush doors: 05 0587 00335



Franz Schneider
Brakel GmbH + Co KG

FSB

Nieheimer Straße 38
33034 Brakel
Germany

Phone +49 5272 608-0
Fax +49 5272 608-300
www.fsb.de · info@fsb.de